



# KODIAK 20



## Spare Parts manual

Serial number reference:

- 20023900-
- 2000000000 -
- 2000200000 -
- 2000400000 -
- 2000500000 -
- 2000700000 -
- 2000800000 -
- 2001000000 -
- 2001100000 -
- 2001300000 -

## Varimixer

Varimixer A/S  
Elementfabrikken 9  
DK-2605 Brøndby  
Denmark

P: +45 4344 2288  
E: info@varimixer.com  
www.varimixer.com



EN

DRN:24020-160203  
29-04-2026

## ORDERING OF SPARE PARTS:

Sale of spare parts for our mixers is attended by our spare part department. When ordering spare parts, the following information must be given:

1. Type of machine
2. Number of the machine
3. Article number of the spare part in question. (Order no.)
4. Method of conveyance

If one of the above pieces of information is missing, please contact our spare part department before placing the order, as then we can assist you in finding the correct article number (order no.) of the spare part in question.

A few spare parts are not sold alone, in such cases reference is made at the pos.number to the assembly number to be used for ordering. The assembly numbers are shown on the relevant pages.

Returning of spare parts is only  
allowed when agreed with  
Varimixer A/S

**CONTENTS**

<b>TRANSMISSION</b>	<b><u>4</u></b>
<b>ATTACHMENT DRIVE</b>	<b><u>5</u></b>
<b>ASSEMBLED PLANETARY HEAD</b>	<b><u>6</u></b>
<b>PLANETARY HEAD</b>	<b><u>7</u></b>
<b>MACHINE HOUSING</b>	<b><u>8</u></b>
<b>LIFTING SYSTEM</b>	<b><u>10</u></b>
<b>ELECTRIC COMPONENTS</b>	<b><u>12</u></b>
<b>FRONT PANEL</b>	<b><u>14</u></b>
<b>ACCESSORIES</b>	<b><u>15</u></b>

ORDER NO.	DESCRIPTION
CR20-85ZB	Motor CR10/CR20, 750W
CR30-90ZB	Drive belt CR20 & CR30
CR20-129ZB	External belt pulley CR10/20

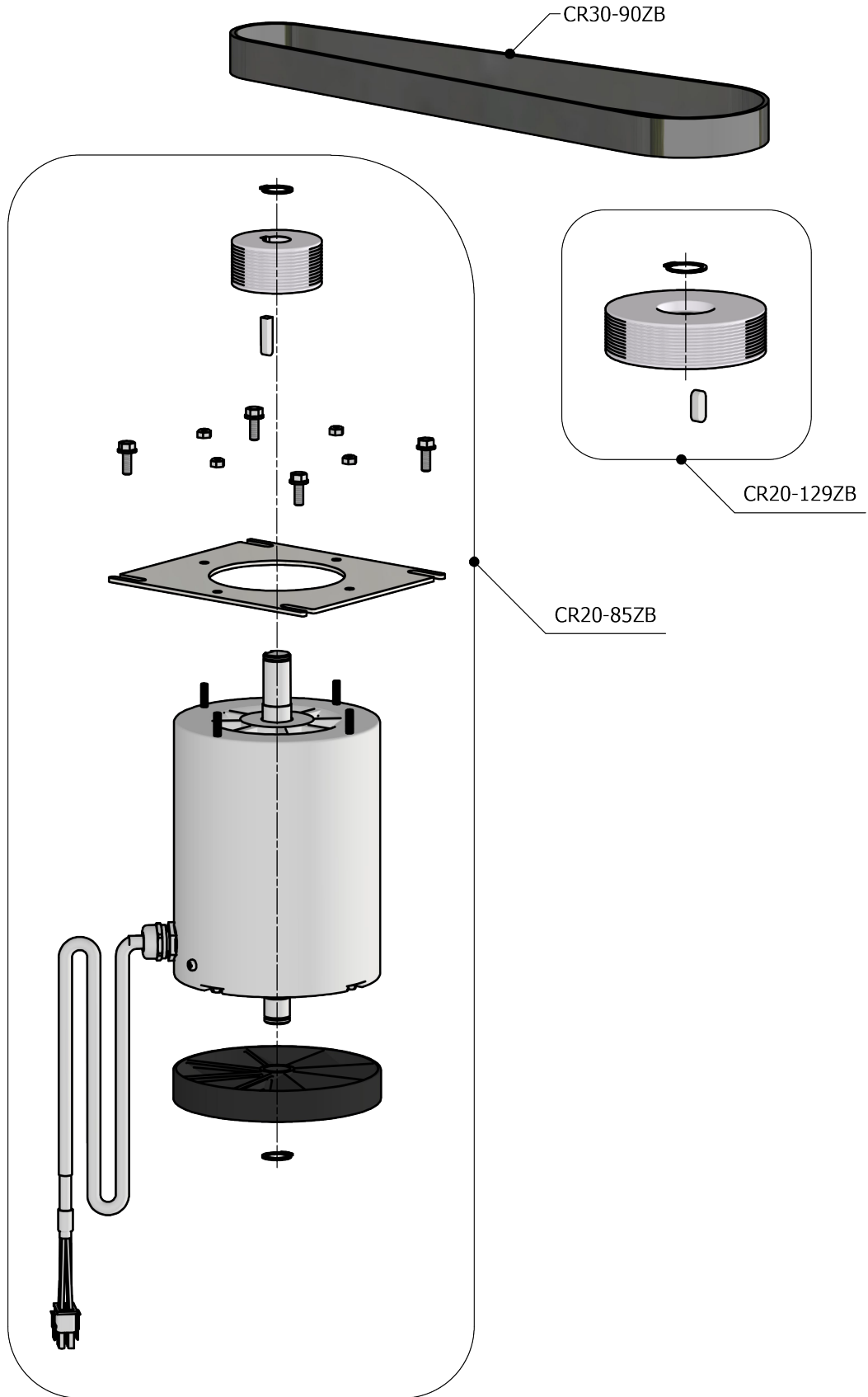

ORDER NO.	DESCRIPTION
CR20-10MZB	Attachment drive complete CR20/30 Kodiak
CR30-211ZB	Cover CR20/30
RN20-9ZB	Worm Gear Set CR20
CR20_30-HAZB	Aux Shaft Kit CR20/30
CR20-HHZB	CR20 Aux Housing Kit
R15-215.1ZB	CR20 Blanking Cover

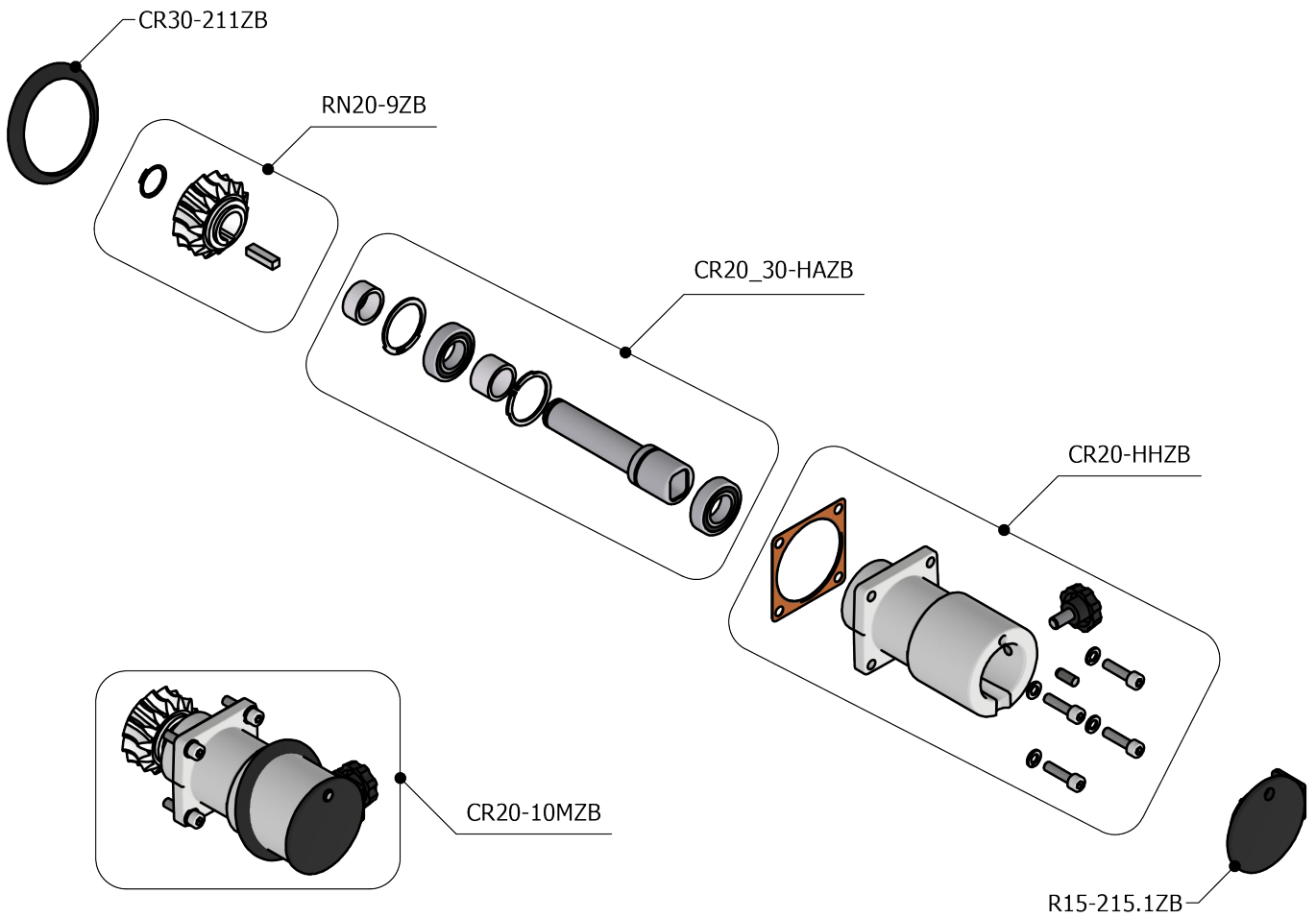

ORDER NO.	DESCRIPTION
CR20-2.5MZB	Planetary head with scraper holder comp.
CR20-2.4MZB	Planetaryhead with scraber and attachmen

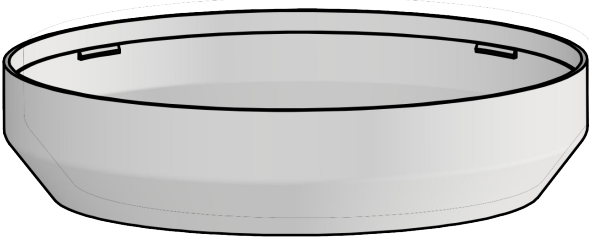
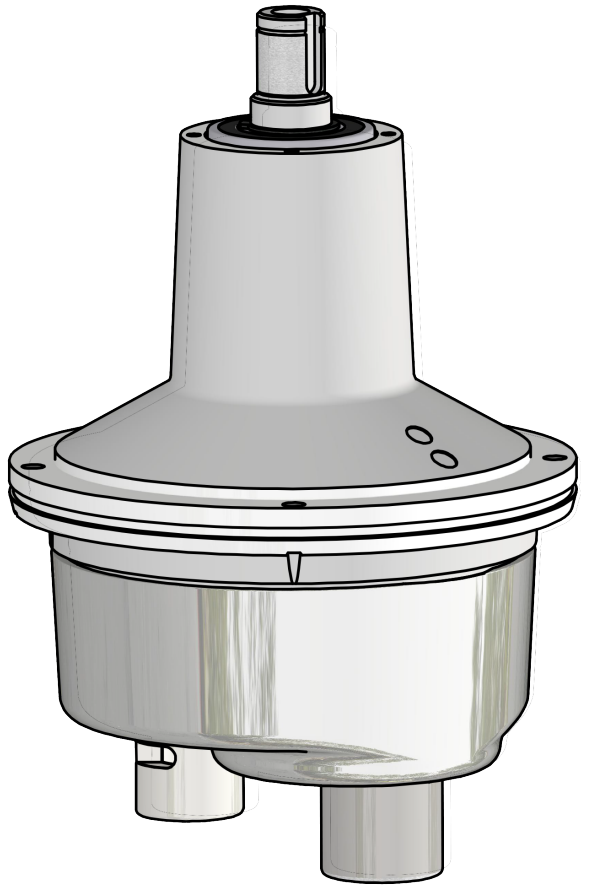

CR20-2.5ZB  
CR20-2.5ZB

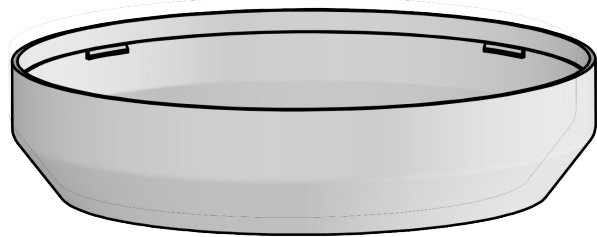
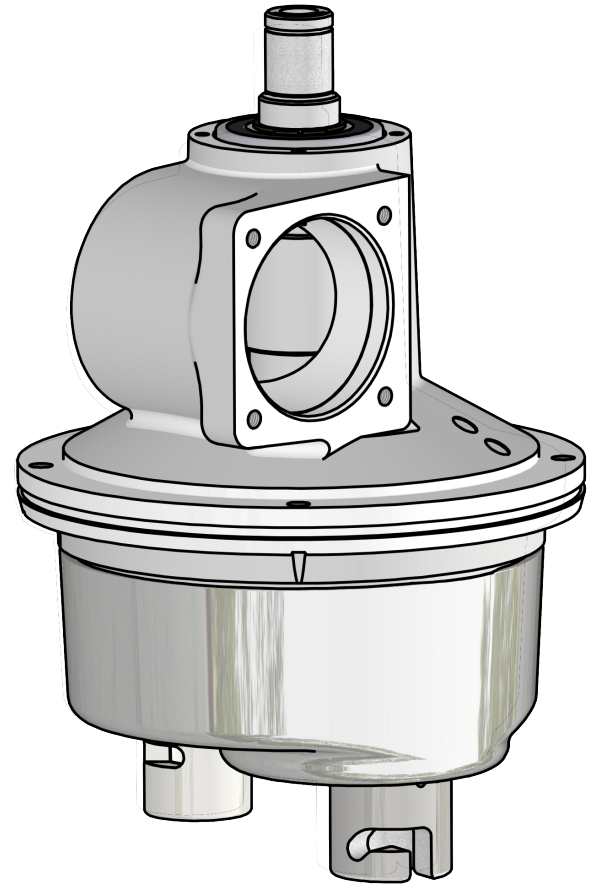

CR20-2.4ZB  
CR20-2.4ZB

ORDER NO.	DESCRIPTION
CR20-RLZB	Bearing set for CR20 & CR30 mixer head
CR20-RBZB	Bayonet shaft set CR20
CR20-RHZB	Main shaft set CR20/30
CR20-RPZB	Planet gear set CR20/30
CR20-33.7ZB	Bayonet shaft set CR20
CR20-RBBZB	Bayonet bushing set CR20/30
RN20-272.1ZB	CR20/30 cover for planetary head upper

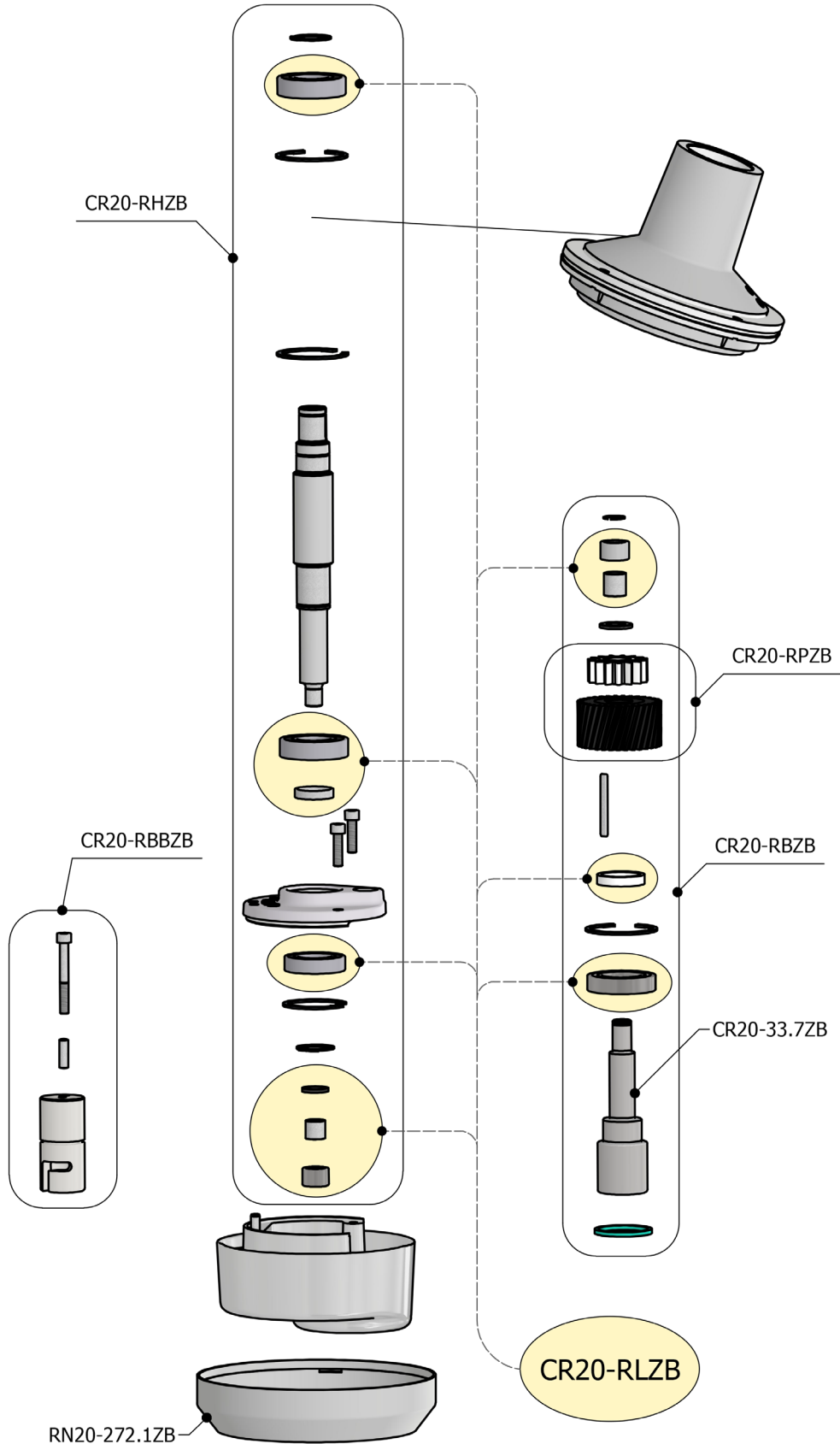

**MACHINE HOUSING****8**

<b>ORDER NO.</b>	<b>DESCRIPTION</b>
CR30-304ZB	CR20/30 NSF Coverplate
STA5750	///Hex flange Screw M6x16 FZB
56CR20-111ZB	Microswitch bowl detection incl. Bracket
WR20-552.6MZB	Frequency converter 750W-120V complete
WR30-552.4MZB	VFD CR20 200-208V CR30 100-120V&400-480V
WR20-552.4MZB	CR20/30 Frequencyconverter complete WR20
CR30-22.18ZB	Rotary lock set CR10
CR20-291ZB	CR20/30 Back Plate Kit
CR20-551ZB	CR20/30 Sealing lid
CR20-21.1RZB	CR20/30 Lid CR20
CR20-430.3ZB	CR20/30 Transformer 400-480V
CR20-STA.S	Bolt set for CR20/30 machine housing
56CR20-110ZB	CR20/30 Contact Plate & Bracket Kit
56CR20-280ZB	Kodiak 20 filling tray for hot ingredien
56CR20P-22ZB	Safety guard CR20
CR20-218ZB	CR10/20/30 Adjustable leg
CR20-218.1ZB	Rubber foot CR
CR20B-218ZB	Adjustable foot CR
CR20-218RZB	Foot Adjustable stainless MARINE CR20/30
CR20B-219RZB	Welding base marine set CR

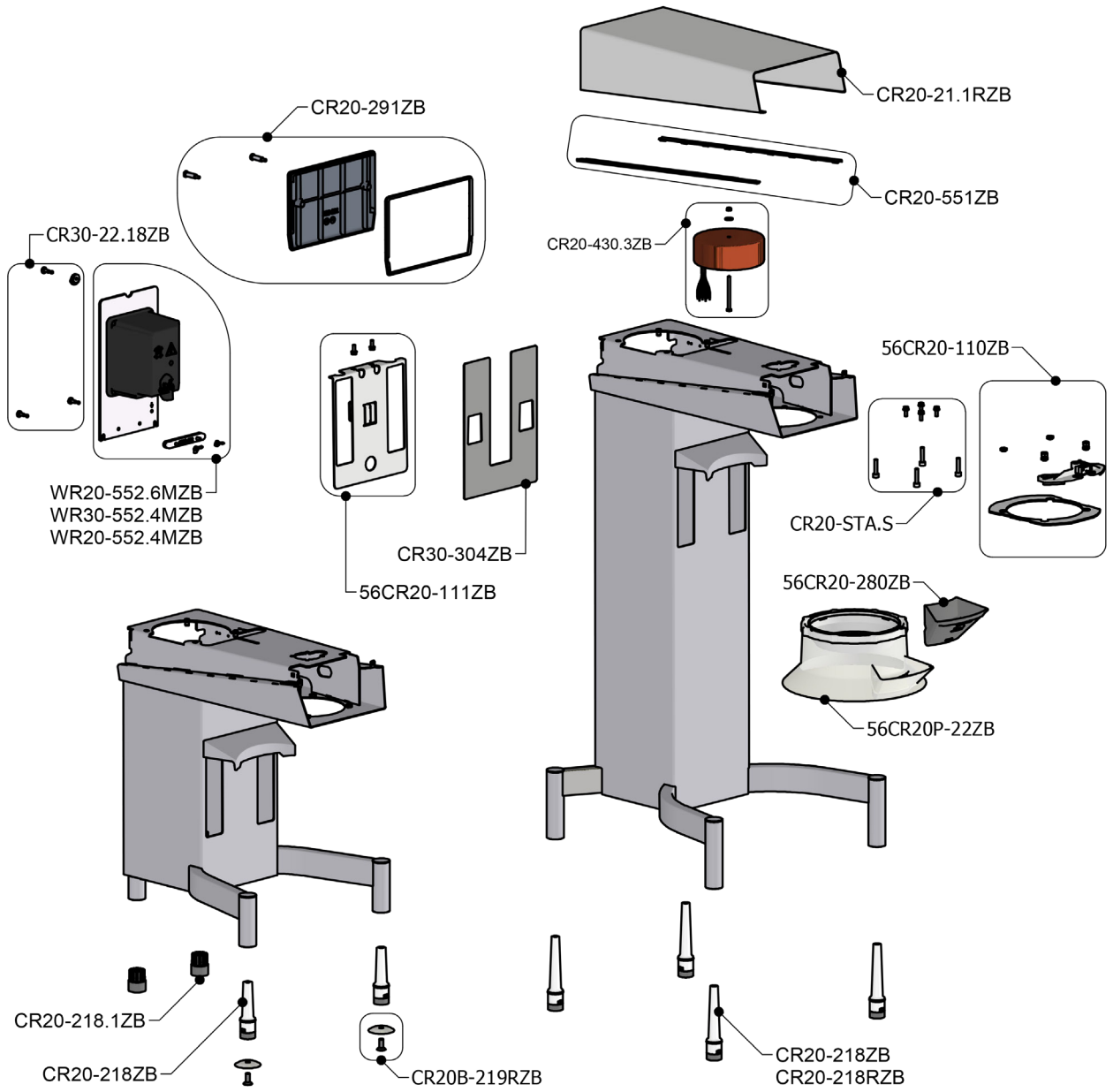

ORDER NO.	DESCRIPTION
CR20-62MZB	Lifting Handle Kit
CR30-63MZB	CR20/30 Crank Kit
CR30-83.1MZB	CR20/30 Lifting Bolt Kit
CR20-110ZB	CR20/30 Tensile spring boiler lift
CR20-23.5ZB	CR20/30 NSF gasket
CR20-23MZB	CR20 Bowl arm mounted with pins/bushing
CR20-68.5ZB	Bowlarm shaft CR20/30

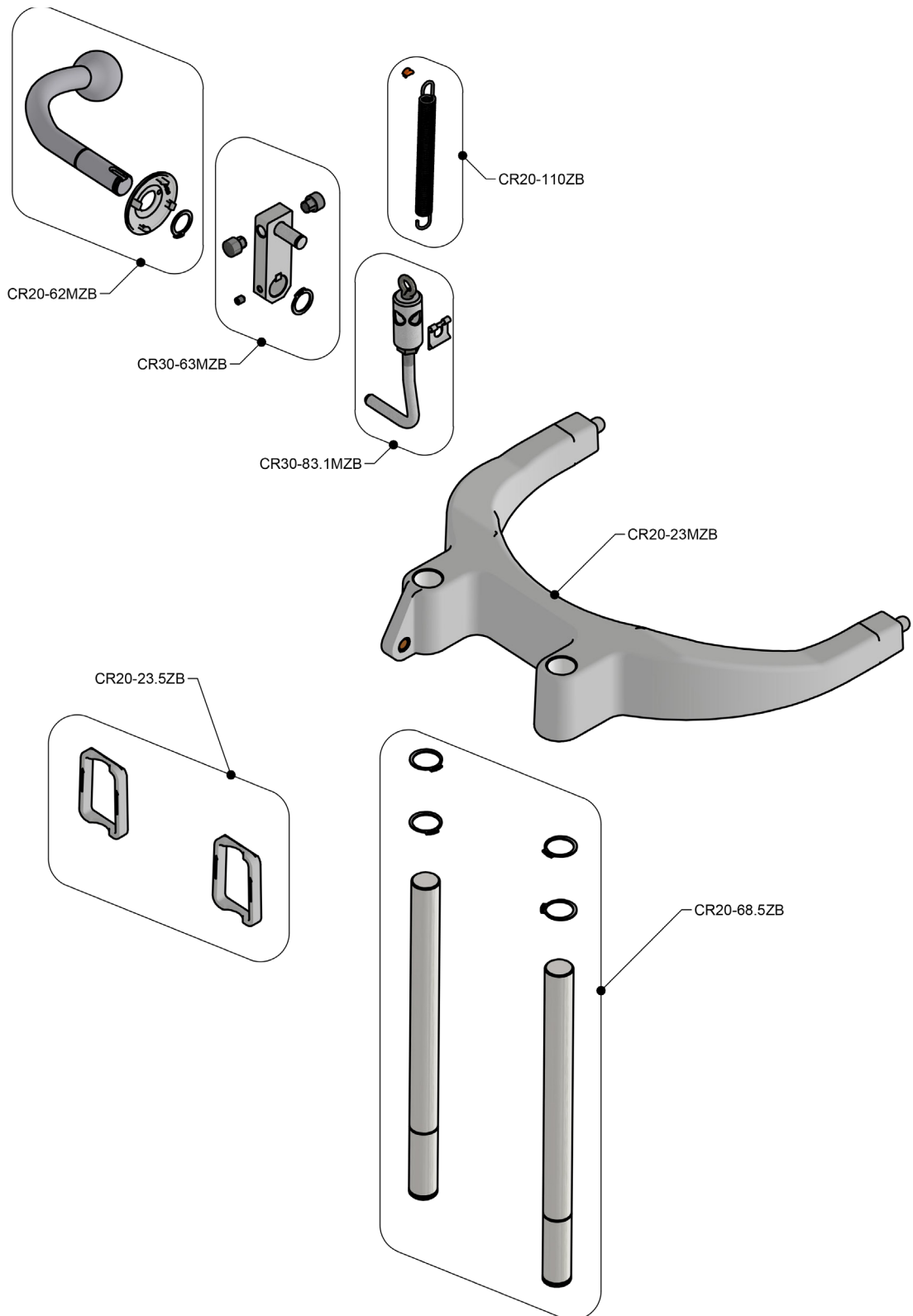

This page intentionally left blank

<b>ORDER NO.</b>	<b>DESCRIPTION</b>
CR10-194.102MZB	Power supply cable EU
CR10-194.104MZB	Main cable CH CR
CR10-194.106MZB	Power supply cable US + CAN
CR10-194.112MZB	Power supply cable Without plug
CR10-194.10ZB	Communication cable
CR10-550.3ZB	Kodiak Comm. Cable Seal
CR10-542ZB	Main circuit cable for CR10
CR30-543.2ZB	Connection Cable
CR10-601.1ZB	CR20/30 EMC Filter
CR10-545.1MZB	Ground choker mounted
CR10-543.6MZB	Power supply cable
CR20-543.4MZB	Cable, Fuse to Trafo
CR20-194.8MZB	Ground Cable
R20E-418.21ZB	Fuse Slow 12.5A, Ø6.3 x 32mm, 500V

CR10-194.10ZB



CR10-550.3ZB

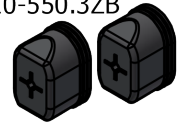

CR10-542ZB



CR30-543.2ZB

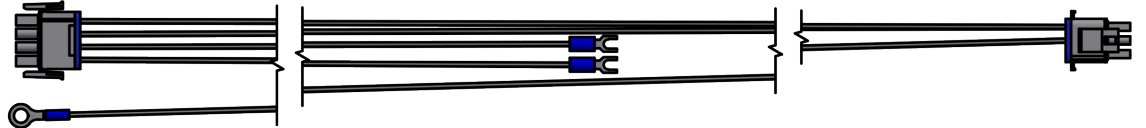

CR10-601.1ZB



CR10-545.1MZB

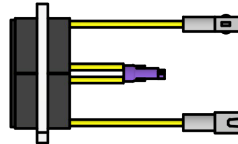

208 - 230V

CR10-543.6MZB

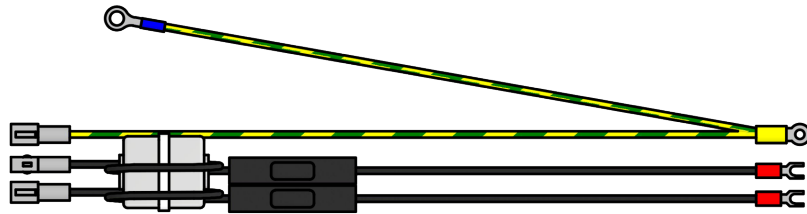

400 - 480V

CR20-543.4ZB

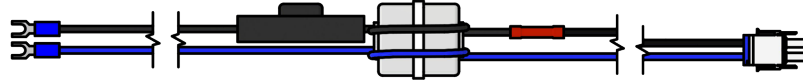

CR20-194.8MZB



CR10-194.102MZB



CR10-194.104MZB



CR10-194.106MZB





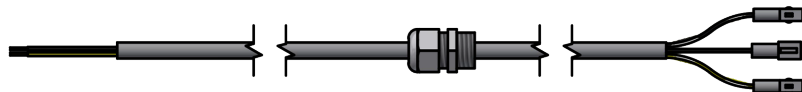

CR10-194.112MZB

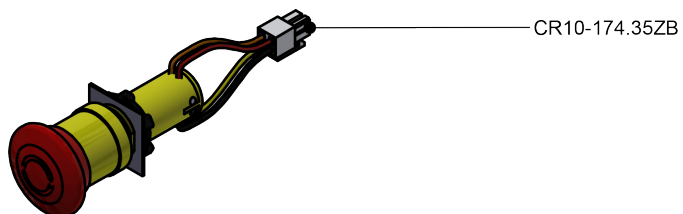
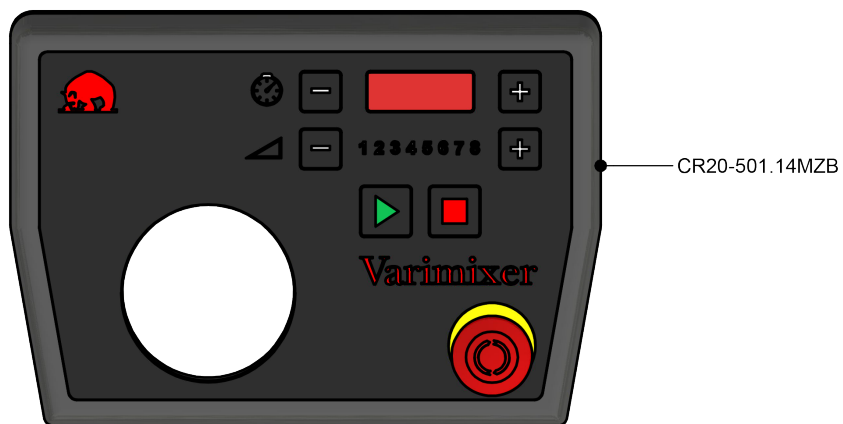
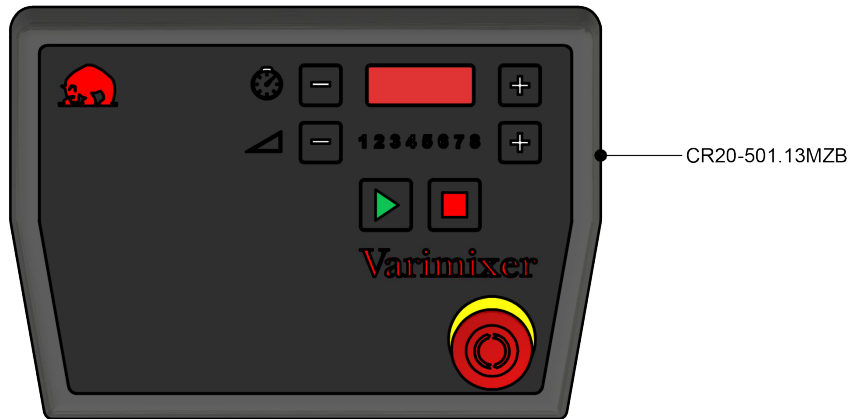
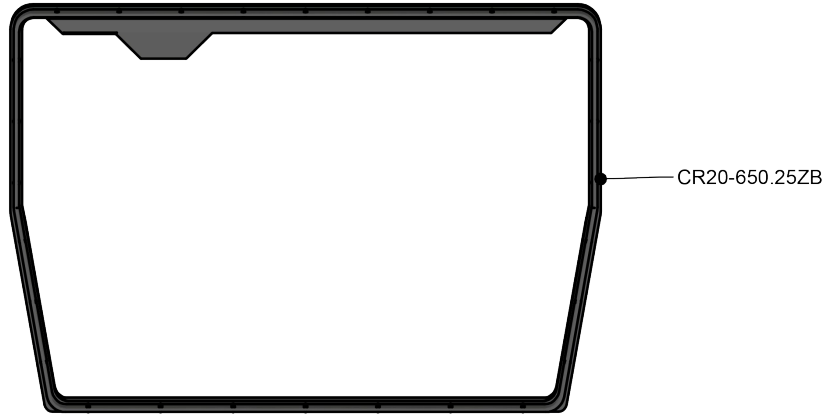

ORDER NO.	DESCRIPTION
CR20-501.13MZB	Frontpanel, VL1C 100-240V mounted
CR20-501.14MZB	Frontpanel, VL1C HUB 100-260V mounted
CR20-650.25ZB	Gasket for frontpanel
CR10-174.35ZB	Emergency stop RN10, complete

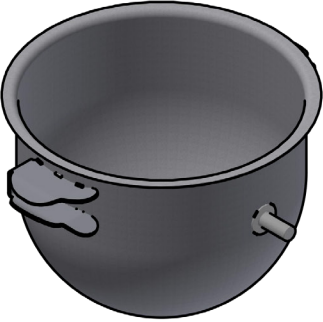

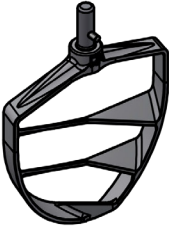
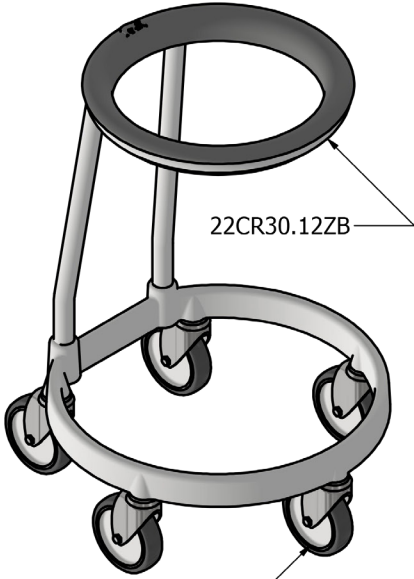
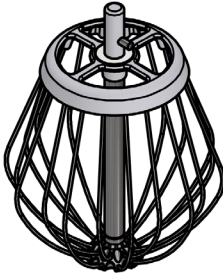
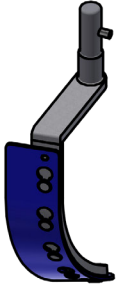
ORDER NO.	DESCRIPTION
CR20-75MZB	CR20L bowl
CR20-75AMZB	CR20/12L bowl
CR20-78MZB	CR20 Hook
CR20-78AMZB	Hook 20/12L CR20L
CR20-27.2MZB	CR20L Beater
CR20-27A2MZB	CR20/12L Beater
CR20-28.3MZB	Axlewhisk 20L complete
CR20-28.3AMZB	Axlewhisk CR20/12L complete
42CR20-202ZB	Scraper standard PE CR20/20L
42CR20A-202ZB	Scraper standard PE CR20/12L
42CR20-204ZB	Scraper blade standard PE CR20/20L
42CR20-204TZB	Scraper blade heat-res PTFE CR20/20L
42CR20-204AZB	Scraper blade standard PE CR20/12L
42CR20-204ATZB	Scraper blade heat-res PTFE CR20/12L
22CR20ZB	Bowltruck Kodiak CR20/30
22CR20-33ZB	CR20 Bowltruck MARINE
22CR30.12ZB	Bearfoot
22CR20-520ZB	Wheel for Bowl truck ø100 Tente

 <p>CR20-75MZB CR20-75AMZB</p>	 <p>CR20-78MZB CR20-78AMZB</p>	 <p>CR20-27.2MZB CR20-27A2MZB</p>	 <p>22CR20ZB 22CR20-33ZB</p> <p>22CR30.12ZB</p> <p>22CR20-520ZB</p>
 <p>CR20-28.3MZB CR20-28.3AMZB</p>	 <p>42CR20-202ZB 42CR20A-202ZB</p>	 <p>42CR20-204ZB 42CR20-204TZB 42CR20-204AZB 42CR20-204ATZB</p>	



# Varimixer

Varimixer A/S  
Elementfabrikken 9  
DK-2605 Brøndby  
P: +45 4344 2288  
E: [info@varimixer.com](mailto:info@varimixer.com)  
[www.varimixer.com](http://www.varimixer.com)